

System Controller  
SC-301-6M



**CAUTION**

In order to use this product safely, read this installation manual carefully and follow the installation instructions.

# Installation Manual

Potential dangers from accidents during installation and use are divided into the following two categories. Closely observe these warnings, they are critical to your safety.



**WARNING**

WARNING indicates a potentially hazardous situation which, if not avoided, could result in death or serious injury.



**CAUTION**

CAUTION indicates a potentially hazardous situation which, if not avoided, may result in minor or moderate injury.

## Requests to Installers



**WARNING**

In order to use this product safely, read this installation manual carefully and follow the installation instructions.

- Failures and damage caused by erroneous work or work not as instructed in this manual are not covered by the warranty.
- Refer to installation manual attached to the appliance as well.
- Check that installation was done in accordance with this Installation Manual upon completion.
- After completion of installation, be sure to hand this Installation Manual to the customer.



- When you fasten the screws on the terminals (Warning lamp terminal and so on), do not use electric drivers, impact drivers and so forth. Tightening with excessive force may cause the terminals to be damaged and lead to failures.

## Contents



1. Included Accessories .....	2	8. Recirculation Pump Timer Setup .....	13
2. Required Accessories .....	2	9. System Check Button .....	15
3. Introduction .....	3	10. Maintenance Monitors and Additional Settings .....	16
4. Installing the System Controller .....	4	11. Additional Remote features .....	18
5. Wiring Diagram, System Diagram .....	6	12. Additional System Controller Features .....	20
6. Remote buttons and display overview .....	7	13. System design, Gas, and Water piping .....	24
7. Remote initial setup .....	9	14. Follow-up Service .....	28

If at any time during the installation and setup of this product you have questions or concerns, please contact Noritz America Engineering & Service at 866-766-7489 or visit <http://support.noritz.com/>.



# 1. Included Accessories

Check for any missing items before starting installation.

Part	Shape	Qty	Part	Shape	Qty
Tapping Screw (4 x 8)		3	*1 Vinyl Tie		3

\*1 : Use the included vinyl tie to bind any excess length of wire

# 2. Required Accessories

Name	Usage	Qty
Remote controller RC-9018M	* Always necessary.	1
Remote controller Cord RC-CORD10 RC-CORD26	-The communication cord between the system controller and the remote controller can be lengthened up to a maximum total length of 450 feet. -The communication cord between the system controller and each water heater can be lengthened up to a maximum total length of 45 feet.	Total number of units in system - 1

CAUTION : Be sure to use the remote controller cord as listed above. If a different cord is used, the equipment may fail or not operate properly.

● When two or more multi-unit systems are installed in parallel

One remote controller is necessary for each multi-unit system (i.e. 3 multi-unit systems will require 3 system controllers and 3 remote controllers). Each system will have separately wired remote controller cords.

■ For the combined use pattern

A. When there is no circulation pipe (standard type)

Number of units	System controller	Remote controller
1 to 6	SC-301-6M	RC-9018M

B. When there is a circulation pipe

Condition	Number of units	System controller	Remote controller
Recirculation type (circulation heat-retention with external pump)	1 to 6	SC-301-6M	RC-9018M
Storage Tank Recirculation type (circulation heat-retention with external pump)	1 to 6	SC-301-6M	RC-9018M

# 3. Introduction (see list of points below)

## Introduction to the "SC-301-6M" System Controller

### Overview

This manual is intended to provide instruction for the installation, operation, and features of the SC-301-6M system controller. It is divided into 4 main sections:

1. Installation of the SC-301-6M system controller
2. Initial programming of the RC-9018M remote controller
3. Additional features of the RC-9018M remote controller and the SC-301-6M system controller
4. Plumbing diagrams and general information about water and gas piping

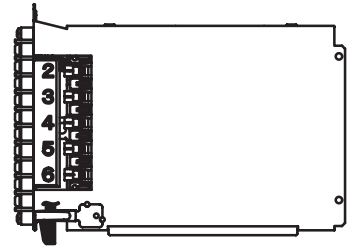

Please read this manual carefully and follow the instructions as written. If you have any questions, please contact Noritz Engineering & Service at 866-766-7489 or visit <http://support.noritz.com/>.

### Basic Operation

The SC-301-6M system controller is used to combine 1 to 6 Noritz heaters into a single "multi-unit system". The system controller stages units on and off based on hot water demand and rotates their operation to ensure even usage. It also has two additional modes which optimize the system for operation with a recirculation line or storage tank.

(Note: for systems of 7-12 units please use the SCU-301-12M system controller)

### Unit Staging

Staging allows the multi-unit system to track hot water demand from the minimum flow rate of a single unit up to the maximum output of several units. When the primary firing heater reaches ~50% of its maximum output, the system controller activates the next unit in the system. When both these units reach ~50% of their maximum output, a third unit is activated and so on. The SC-301-6M may also be configured to activate two heaters during primary firing to allow for rapid initial hot water demand.

### Unit Rotation

The SC-301-6M system controller rotates operation of the primary firing heater every 8 hours of combustion time or up to 24 hours of plug-in time. This helps to ensure even usage of all units.

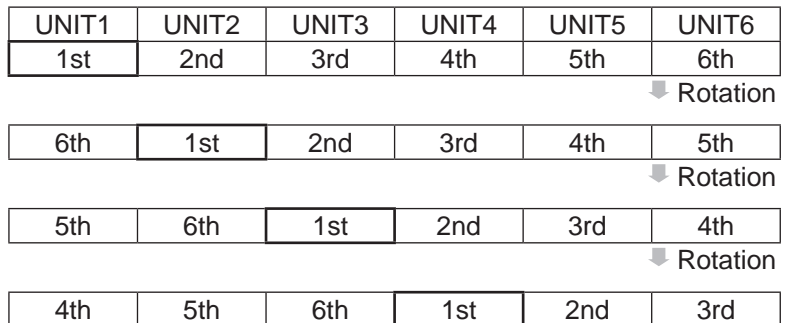

### System Selection

The SC-301-6M allows the user to select two additional system types: "Recirc" and "Tank recirc." These settings optimize performance with recirculation and storage tank systems, and allow the system controller to operate one or two pumps.

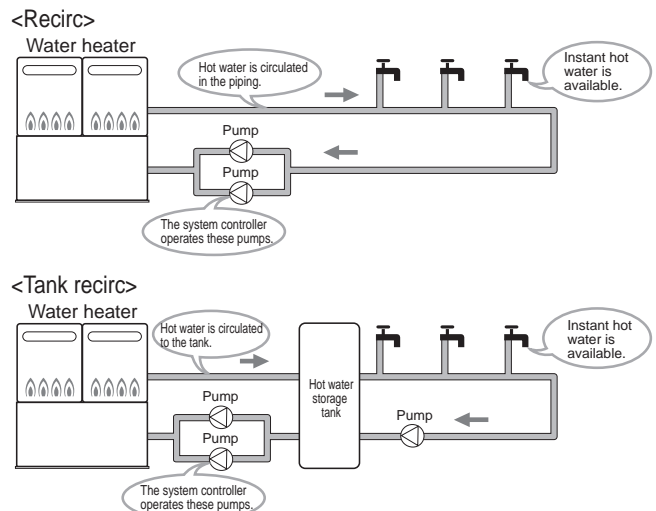

\* These diagrams are for illustration purposes only.

## 4. Installing the System Controller (electrical Wiring section)

Consult a qualified electrician for the electrical work.



### CAUTION

- Do not connect electrical power to all water heaters (do not turn ON the power supply) before all electric wiring is completed. Otherwise, electric shock or failure of the water heater and system controller may occur.
- If a remote controller cord is not connected, the temperature of the water heater is fixed to 120°F (50°C) and high-temperature hot water is discharged. So check it is surely connected.
- Be sure to tighten the screw to the terminal block manually and do not use an electric screwdriver or impact driver. Otherwise, the terminal block may be damaged.

This appliance must be electrically grounded in accordance with local codes, or in the absence of local codes, with the National Electrical Code, ANSI/NFPA 70. In Canada, the latest CSA C22.1 Electrical Code.

**Caution:** Label all wires prior to disconnection when servicing controls. Wiring errors can cause improper and dangerous operation.  
Verify proper operation after servicing.  
Field wiring to be performed at time of appliance installation.

#### ■ For NCC1991 series

\* Circuit board is indicated as P.C.B.

Open the cover of the external remote controller cord terminal block of each water heater.

#### ● Construction work for unit 1 (Water heater to which system controller is attached)

Operation	Illustration
<p>Open the front cover</p> <ol style="list-style-type: none"> <li>1. Connect the remote controller cord to the external remote controller cord terminal block. (Refer to the remote controller RC-9018M section of the installation manual).</li> <li>2. Connect the opposite side of the remote controller cord that was connected in the step 1 to the remote controller. * Refer to the installation manual.</li> <li>3. Slide the system controller into the bracket in the back of the case. Use the two included tapping screws to attach the system controller to the inside of the heater and to connect the ground wire.</li> </ol>	
<ol style="list-style-type: none"> <li>4. 1) Connect the connector B5 (white: nothing is connected when the product is shipped from factory) with a tag "SYSTEM CONTROLLER" that comes from the P.C.B. of the water heater to the connector B5 (white) with a red tag "to Connector B5" that comes from the system controller.</li> <li>2) Disconnect the connector (white) from the external remote controller cord terminal block of the water heater and the connector 90 (white) connected to the P.C.B.</li> </ol>	
<ol style="list-style-type: none"> <li>3) Connect the connector 90 (white: removed in the step 2)) that comes from the external remote controller cord terminal block of the water heater to the connector 90 (yellow) with a tag "to Remote Controller Terminal" that comes from the system controller.</li> <li>4) Connect the connector 90 (white: removed in the step 2)) that comes from the P.C.B. of the water heater to the connector 90 (yellow) with a tag "to Connector 90" that comes from the system controller.</li> </ol>	

● Construction work for each water heater of unit 1 (Unit 2 to 6: water heater to which the system controller is not attached)

Operation	Illustration
<p>5. Using the remote controller cord from each water heater, plug the connector into the system controller plugs for units 2-6. (The number of the remote controller cords necessary is determined by the total number of heaters minus one.)</p> <p>1) Connect the connector for the communication cord with unit 2 of the system controller with the connector side of the remote controller cord. The connector No.2 is for unit 2 and the connector No. 3 is for unit 3.</p> <p>* When the system controller is attached, take care not to damage the electric component in the water heater and bond the slack electric component with the included vinyl tie so that it floats on the bottom surface.</p>	

● Construction work of each water heater (Unit 2 to 6: water heater to which system controller is not attached)

<p>6. Connect Y terminal side of the remote controller cord that was connected in the step 5 to the corresponding external remote controller cord terminal block of unit 2 to 6.</p>	<p>* Do not have to open the front covers of these units.</p>
--	---

\* After all connections are made, replace the front cover of unit #1 (taking special care to do not crush any wires) and the covers of the external remote controller cord terminal blocks of all connected water heaters.

# 5. Wiring Diagram, System Diagram

## ■ Wiring Diagram (Multi-unit System Wiring)

◆ When six units are installed

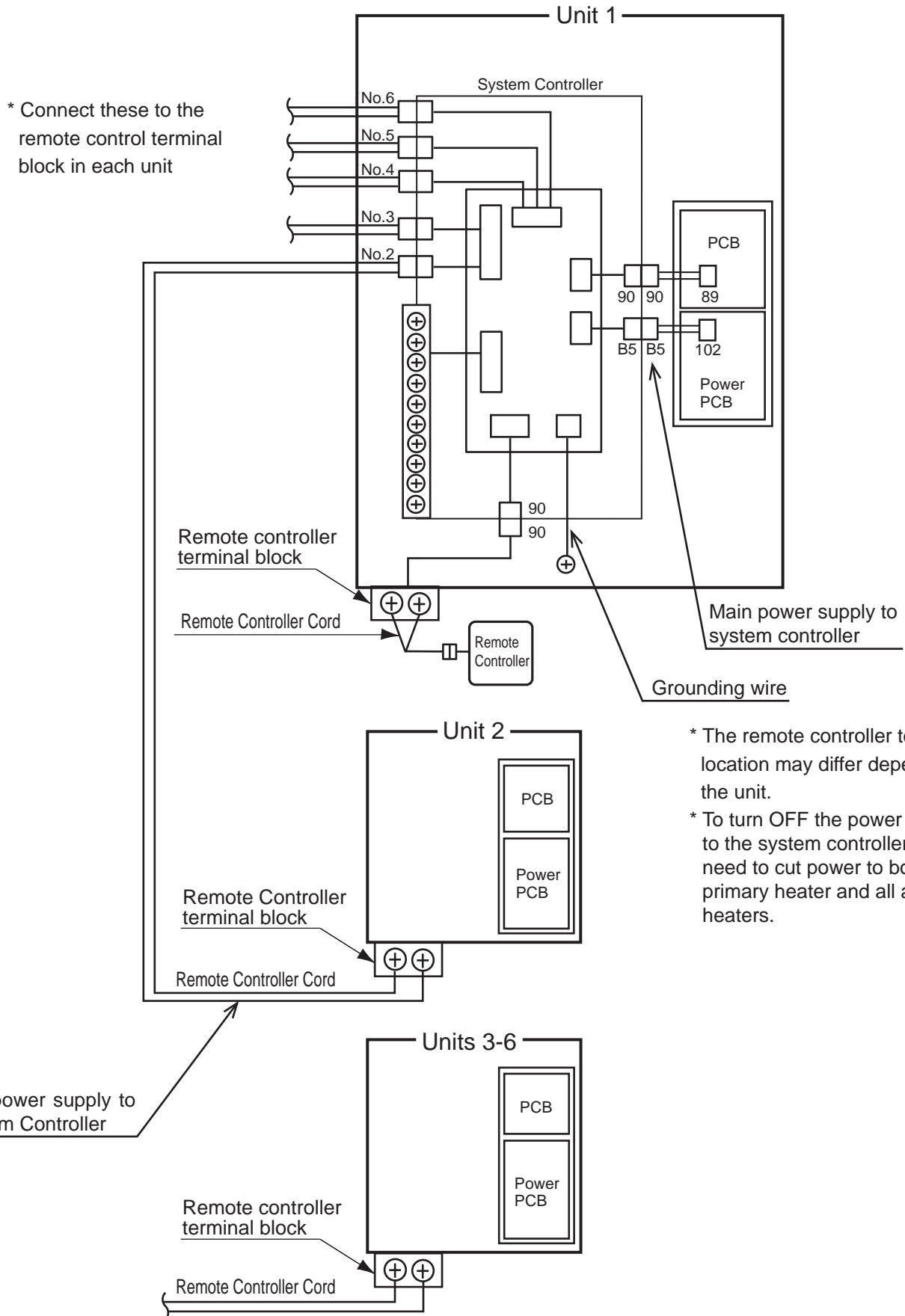

## 6. Remote button and display overview

### Remote Controller (Required Accessories : RC-9018M)

◆ The remote controller will emit a tone when a button is pressed.

\* This Remote Controller is not resistant to water, steam, chemicals, or UV rays. Please install it in a location where it will not be exposed to these conditions. If it must be installed outdoors, please use a weatherproof enclosure. Consult the RC-9018M Installation Manual for details.

#### Prog Button / Indicator (Red)

Activates the automatic water heater power "ON" or "OFF" setting as determined by the user selected schedule.

#### Power ON/OFF Button / Indicator (Green)

For turning the water heater on/off.

#### Alarm Off Button / Indicator (Red)

Stops the tone that is emitted when an error occurs. (page 28.)

#### Speaker

#### Display Screen

(Next page)

#### Menu Button

\* Use to change system settings or to return to the home screen.  
\* If you press the menu button and press the temperature setting buttons, **Sys monitor** is sometimes displayed. However, do not use this mode as it is meant for installation or service personnel only.

#### Status Button

Check the status of the system or the number of installed units. (page 15, 28.)

#### Remote Controller Part Number

The part number is printed on the surface of the cover.

Cover shown in the open position.

#### Lock Button

Locks remote controller operation. (page 19.)

#### Back Button

Returns to the previous screen while making system settings or checking status.

#### Enter Button

Confirms changes made by the user.

#### Hot Water Temperature Setting Buttons

For setting the hot water temperature, and other settings.

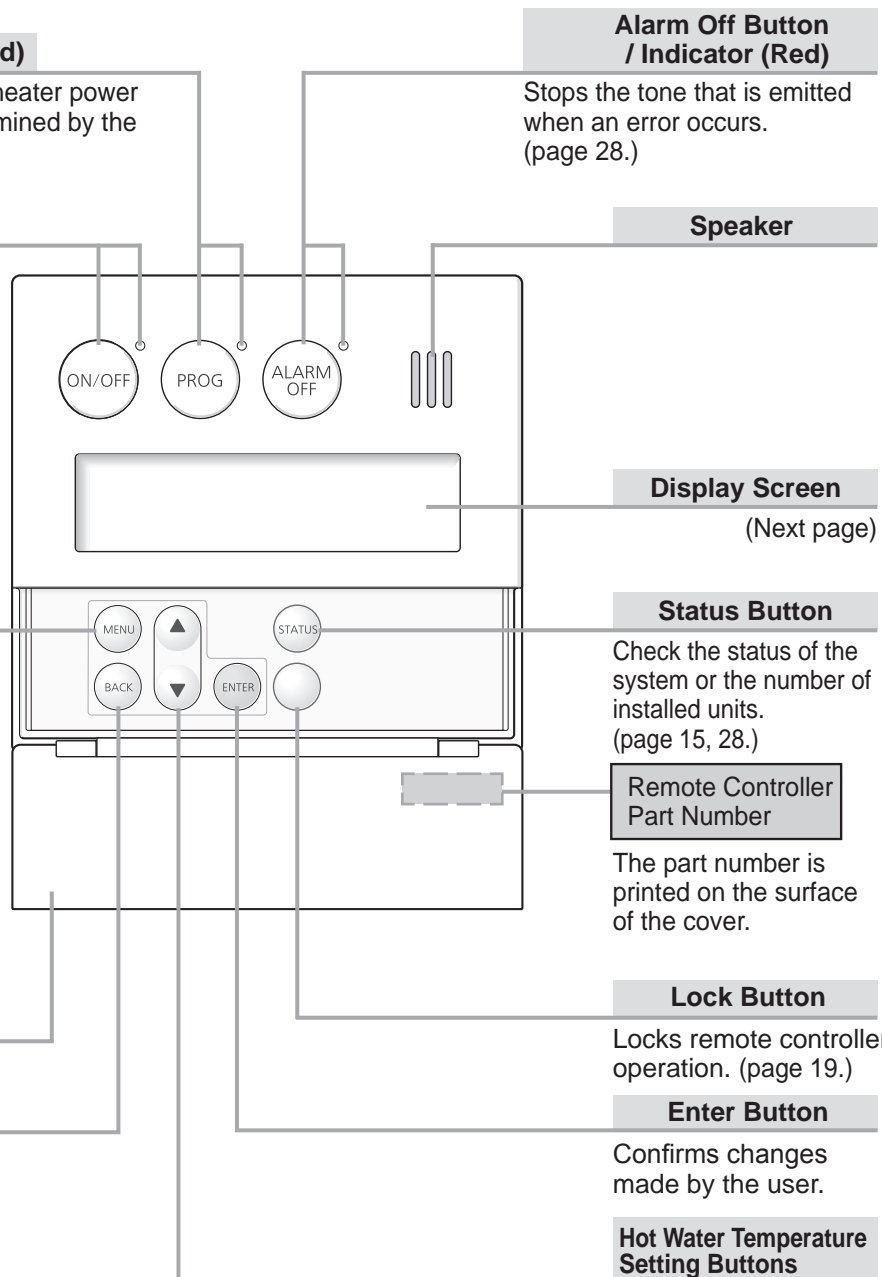

## ◆ Screen Display

- \* The screen display shown below is for illustration purposes only. The actual display will vary depending on how the water heater is being used.
- \* After a button is pressed, the display will gradually become darker to prevent unnecessary power consumption by the remote controller.

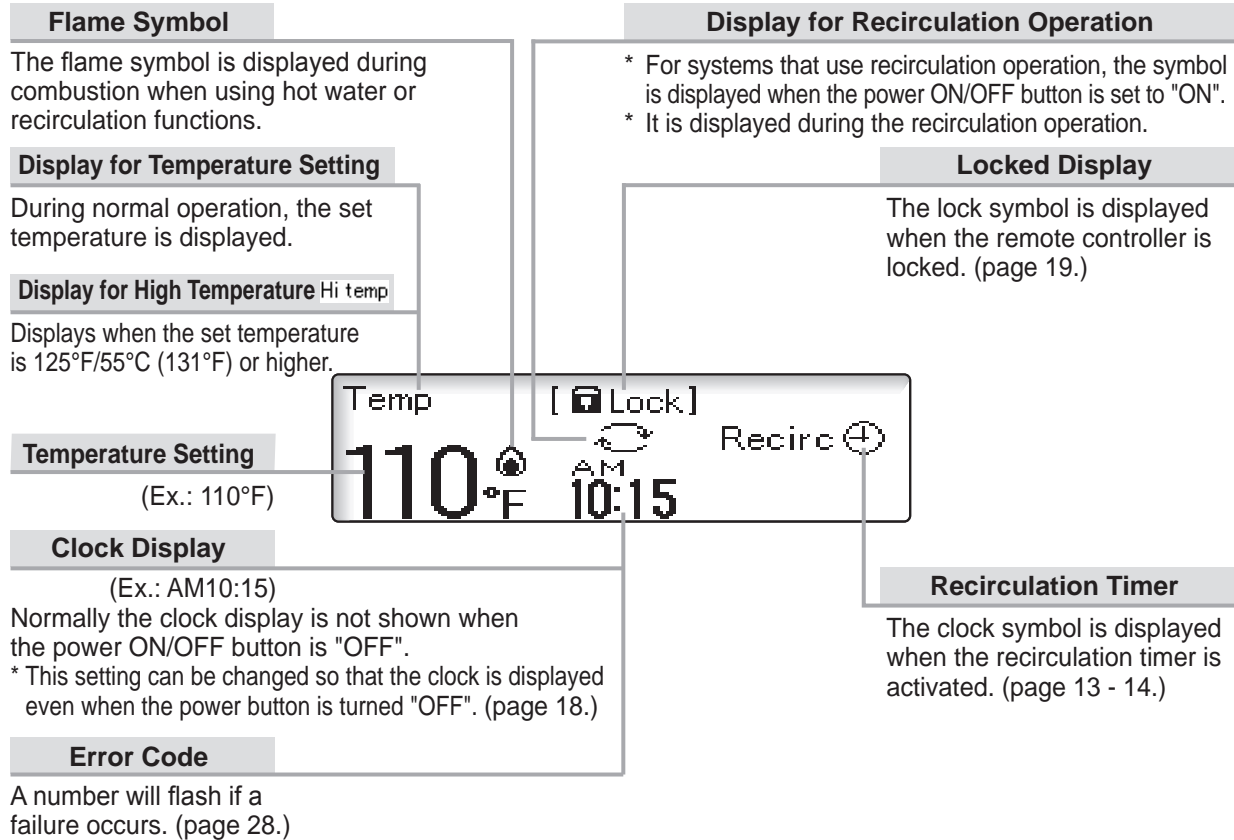

Note: As shipped from the factory, the remote controller is set to display in °F and gallons.  
To adjust the display to °C and liters, refer to the page 12.

## ● What is the home screen? ●

The home screen is displayed when the  button is "ON".

Normally, the hot water temperature and the clock, etc. are displayed.

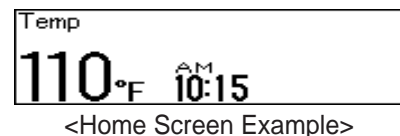



# 7. Remote initial setup

## Initial Setting Procedure in the “System Settings” Screen



Note: When power is first connected to the multi-unit system (system controller and units), the remote enters an initial setting mode. The following instructions explain how to perform an initial setting. If you need to change these settings at a future date, follow the instructions titled System Selection and Settings in the “Initial Settings” Screen (page 10 - 12).

Operation	Screen Display	Description
<b>Preparation</b> Connect power to all heaters in multi-unit system.		
<b>1</b> Press the  button on the remote.		
<b>2</b> 1) You will be prompted to choose a system type. 2) Use the  buttons to navigate to the correct system type. (Standard, Recirc., or Tank Recirc.) 3) Press the  button to select your system type.	  	
<b>3</b> 1) If you chose the “Recirc.” or “Tank Recirc.” systems, you will be prompted to turn pump rotation on or off (this setting is set to “off” by default). 2) Use the  buttons to select yes (on) or no (off). 3) Press the  button to set the pump rotation.		* Note: only when you connect one/two pumps to the system controller, you need to select “Yes” or “No”.
<b>4</b> 1) You will now be prompted to “complete system setting.” 2) Press the  button to complete the system setting. 3) Once you choose “Complete system settings?”, the remote will display “System settings completed”.	 	* Note: if you chose standard system in step 2 - 2), you will immediately go to this prompt. * You may use the  button to return to the previous menu at any time.

## System Selection and Settings in the “Initial Settings” Screen

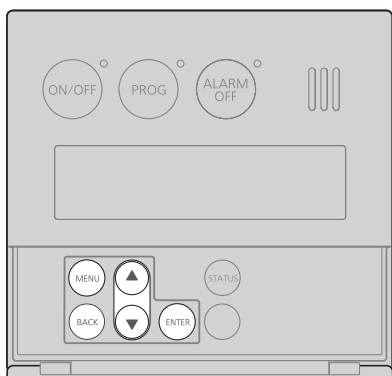

Note: Use this procedure if you need to change the system type or settings after running the “initial setting procedure”

### List of the Initial settings

System type	The system type can be changed.
Sys settings	The system settings can be changed.
[°F/gal]↔[°C/L]	The unit of temperature and flow rate on the screen can be changed.
Adjust clock	The gap of time per month on the clock can be adjusted.
Save backlight	The power saving setting of the backlight on the screen can be changed.

Operation	Screen Display	Description
-----------	----------------	-------------

### Access Initial Settings Menu.

- Preparation**
- 1) Turn Remote off.
  - 2) Disconnect Power to all heaters in multi-unit system.
  - 3) Wait 10 seconds or more.
  - 4) Reconnect power, DO NOT turn remote on.

- 1** Press the  button.

- 2** Use the  buttons “▼” to navigate to “Initial settings”.

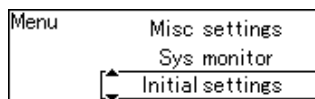

- 3** Press the  button to access the initial settings menu.

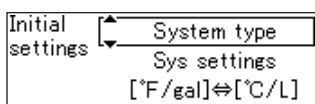

\* You may use the  button to return to the previous menu at any time.

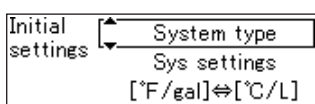

### Change System Type

- 1** In the initial settings menu select “System type”.



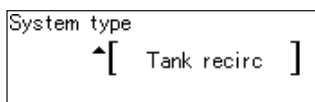



- 2** The menu will have three options: Standard, Recirc., and Tank Recirc.



- 3**
- 1) Use the  buttons to navigate to the appropriate system.
  - 2) Press the  button to select the desired system.

- 4** Once a system is selected, the remote will display “Set Complete”.

\* You may use the  button to return to the previous menu at any time.

Operation	Screen Display	Description
<b>Change System Settings.</b>		
<b>1</b> In the initial settings menu select "Sys settings".	Initial settings ← System type Sys settings [*F/gal] ⇌ [*C/L]	
<b>2</b> 1) The "Sys settings" menu will display several options for the selected system type. 2) Press the  button to select the system setting you would like to alter.	Sys setting ← Quick staging Pump error check Pump rotation	
<b>3</b> 1) Use the  buttons to turn the feature on ("yes") or off ("no"). 2) Press the  button to select "yes" or "no". 3) The display will say "Set complete" once an option is chosen.	Quick staging ↑ [ No ]  Quick staging ↓ [ Yes ]	* You may use the  button to return to the previous menu at any time.

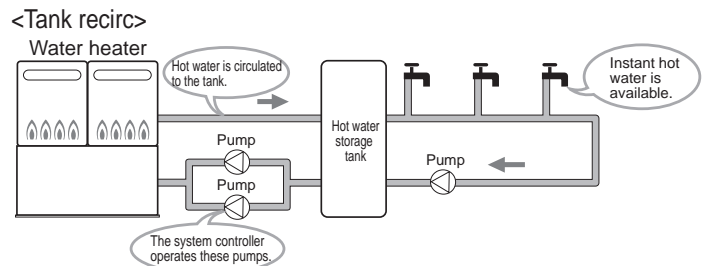
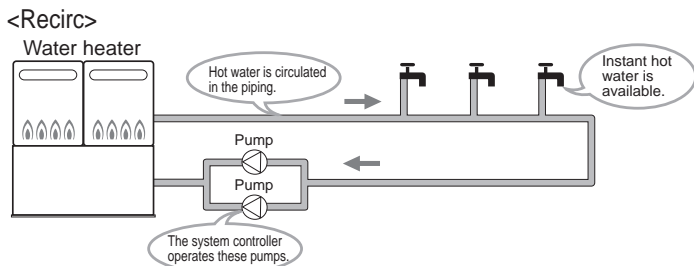
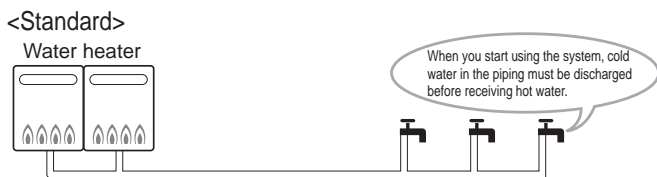





\* These diagrams are for illustration purposes only.

### List of the Sys settings

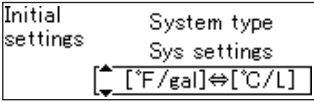
Item in the Sys settings	system type			Yes	No
	Standard	Recirc	Tank recirc		
Quick staging	Available	Available	Not Available	Units will stage more rapidly from heater to heater*	Units will stage more slowly
Pump error check	Not Available	Available	Available	System will check for flow when system controller pump terminals are energized. If no flow is present, it will display 63 error code	System will not check for pump operation*
Pump rotation	Not Available	Available	Available	System will rotate pump 1 and 2 operation	Pump 1 and 2 will operate simultaneously*

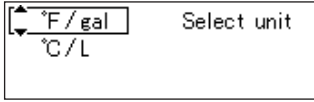
\*Factory Default Settings

Operation	Screen Display	Description
<b>Change the way the units of temperature and flow rate are displayed on the screen (standard vs. metric).</b>		
<p><b>1</b></p> <p>1) In the initial settings menu select “[°F / gal] ⇌ [°C / L]”.</p> <p>2) Press the  button.</p>		
<p><b>2</b></p> <p>1) Use the  buttons to select the unit “[°F / gal]” or “[°C / L]”.</p> <p>2) Press the  button to set the units to be displayed.</p> <p>3) The display will say “Set complete” once an option is chosen.</p>		<p>* You may use the  button to return to the previous menu at any time.</p>
<b>After finishing the Initial Settings.</b>		
<p><b>1</b></p> <p>1) Disconnect Power to all heaters in multi-unit system.</p> <p>2) Wait 10 seconds or more.</p> <p>3) Reconnect power.</p>		

# 8. Recirculation Pump Timer Setup

\*This functionality is only available if you have selected "Recirc" as your system type in the "Initial Setting Procedure" and "System Selection and Settings" on page 9 to 10.

## For System [ Rcirc ] Setting the Recirculation System Operation Timer

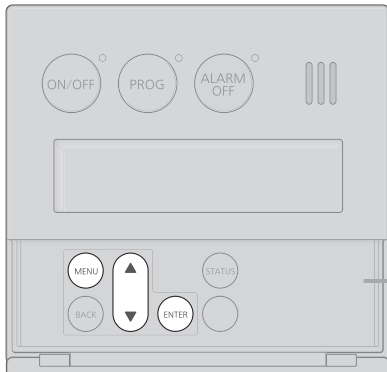

Cover shown in the open position.



\* With the recirculation operation timer set, hot water will be automatically circulated in the hot water pipes. Even with this function activated, it may take several minutes for hot water to be completely circulated through the plumbing system. Set the timer to activate the recirculation system prior to the first use of hot water to ensure hot water is instantly available.

\* Multiple recirculation time periods can be set.

\* Until the timer is deactivated (Next Page), the recirculation system will operate daily at the set times.











\* When the recirculation system is turned "OFF" by the timer, the water heater will still remain "ON" and can be used normally.

Operation	Screen Display	Description
-----------	----------------	-------------

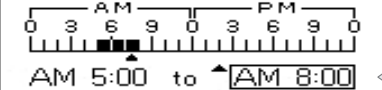
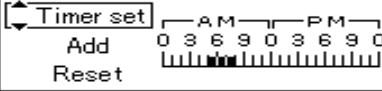
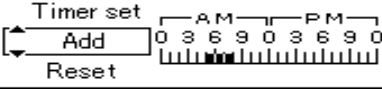
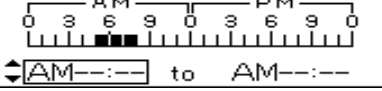
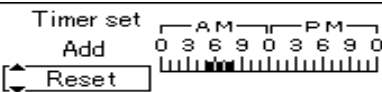
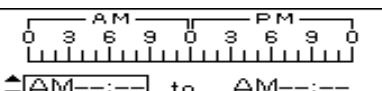

This example describes setting the recirculation system to operate between 5:00 am - 8:00 am.

**Preparation** Check that the current time is properly set.  
(Setting the time page 18.)

<p><b>1</b></p> <p>1) Press the <b>MENU</b> button inside the cover, Select "Recirc menu" using the <b>▲</b> buttons.</p> <p>2) Press the <b>ENTER</b> button.</p>	<p>1) Menu      Set clock                  Set PROG                  ◀ Recirc menu</p> <p>2) Recirc Menu      ◀ Synchro ON/OFF                          Recirc on/off                          Recirc timer</p>	<p>* You can set the timer regardless if the <b>ON/OFF</b> button is "ON" or "OFF".</p>
<p><b>2</b></p> <p>1) Select "Recirc timer" using the <b>▲</b> buttons.</p> <p>2) Press the <b>ENTER</b> button.</p>	<p>1) Recirc Menu      Synchro ON/OFF                          Recirc on/off                          ◀ Recirc timer</p> <p>(Example of a display)</p> <p>2) 0 3 6 9 0 3 6 9 0     AM PM     ◀ AM--:-- to AM--:--</p>	<p>* The previous setting is displayed.</p>
<p><b>3</b></p> <p>1) Select "AM5:00" using the <b>▲</b> buttons.</p> <p>2) Press the <b>ENTER</b> button to complete the "Start" time setting.</p>	<p>1) 0 3 6 9 0 3 6 9 0     AM PM     Here → AM 5:00 to AM 6:00</p> <p>2) 0 3 6 9 0 3 6 9 0     AM PM     AM 5:00 to AM 6:00</p>	<p>* Every time when you press the button, the time changes by one hour.</p> <p>[To keep the current "Start" time] Press the <b>ENTER</b> button without changing the "Start" time, and proceed to step 4.</p> <p>[To add additional time periods to the current setting, or to cancel the previous setting]</p> <p>1) Press the <b>ENTER</b> button without setting "Start" time.</p> <p>2) Press the <b>ENTER</b> button without setting "End" time.</p> <p>3) Follow the procedures "Adding Additional Time Periods" or "Resetting All Time Periods" (<b>Next Page</b>).</p>

Operation	Screen Display	Description
<p><b>4</b></p> <p>1) Select "AM8:00" using the  buttons.</p> <p>2) Press the  button to complete the "End" time setting.</p> <p>&lt;Adding Additional Time Periods&gt;</p> <p>1) Select "Add" using the  buttons.</p> <p>2) Press the  button.</p> <p>3) Select the time period following the procedures in Steps 3 to 4.</p> <p>&lt;Resetting All Time Periods&gt;</p> <p>1) Select "Reset" using the  buttons.</p> <p>2) Press the  button. (All settings are cleared.)</p> <p>3) Adjust the time period following the procedures in Steps 3 to 4.</p>	<p>1)  Here</p> <p>2) </p> <p>1) </p> <p>2) </p> <p>1) </p> <p>2) </p>	<p>* Every time when you press the button, the time changes by one hour. [To keep the current "End" time] Press the  button without changing the "End" time, and proceed to step 5.</p> <p>* You can set multiple operation time periods.</p>
<p><b>5</b></p> <p>Press the  button to complete the time settings.</p>	<p>Set complete</p> <p>▼</p> <p>"Recirc timer" and "Recirc timer on" are alternately displayed on the menu (approximately 10 seconds)</p> <p>▼</p> <p></p> <p>(Example of home screen when the power ON/OFF button is turned "ON")</p>	<p>* The timer will not activate without pressing the  button.</p> <p>* If the time is not set, the time setting screen is displayed.</p> <p>* Until the timer is deactivated, the recirculation system will operate daily at the set "Start" and "End" times.</p>

**● To Cancel the Recirculation System Operation Timer**

- 1) Carry out steps 1 to 2.
- 2) Select "Cancelled" using the  buttons.
- 3) Press the  button.

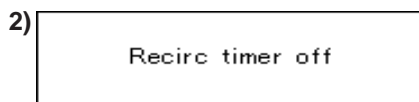
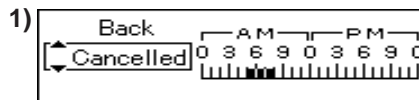

The screen returns to the Recirc Menu.

\* If the  button is "ON", the screen returns to the home screen in approximately 10 seconds.

## 9. System Check Button

If you press the  button, you can check the status of the system

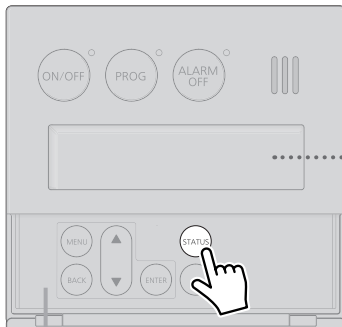





Cover shown in the open position.

```

[System [ Rrcrc ] Active [ 06 ]
Units [ 06 ] Pump1 [ OFF ]
Online [ 06 ] Pump2 [ ON ]
    
```

(Display Screen Example [System [Rrcrc ]])

System Displayed on the Remote Controller	System Description
System [ Std ]	Water heater only operation.
System [ Rrcrc ]	<ul style="list-style-type: none"> <li>* Water heater and recirculation operation.</li> <li>* During recirculation operation, hot water is always circulated in the piping to provide instant hot water when a fixture is opened.</li> </ul> [If you set the  button to "ON",  is displayed.]
System [ Tank ]	<ul style="list-style-type: none"> <li>* Water heater combined with a storage tank operation.</li> <li>* If a recirculation system is also installed, hot water is always circulated in the piping to provide instant hot water when a fixture is opened.</li> </ul> [If you set the  button to "ON",  is displayed.]

# 10. Maintenance Monitors and Additional Settings

\* It is necessary to check the flow rate for Recirculation system, and Storage Tank Recirculation system (for adjusting the cycle flow rate).

- Press Menu Button and press the ▼ Button several times to select "Sys monitor", and then press Enter Button.
- Press the ▼ Button once to select "Yes", and then press Enter Button for five seconds or more.

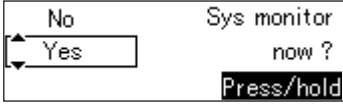

- Sys monitor is displayed. Since item 03 is displayed first, you must push the ▲/▼ Buttons several times until item 14 is displayed.

- Flow rate screen is displayed.

\* The unit of flow rate on the screen can be changed (refer to page 12.)

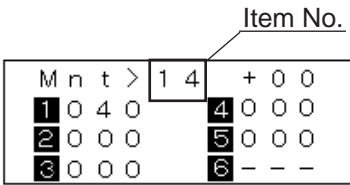

<Example of display (°F/gal)>  
 Flow rate of unit 1 is 4.0 gal/min  
 Flow rate of unit 2 to 5 is 0 gal/min  
 unit 6 is not connected

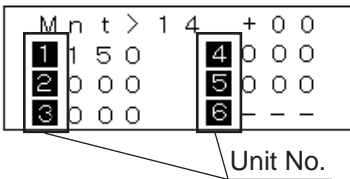

<Example of display (°C/L)>  
 Flow rate of unit 1 is 15.0 L/min  
 Flow rate of unit 2 to 5 is 0 L/min  
 unit 6 is not connected

- Press Back Button.

- The screen that asks whether continue or cancel the Sys monitor is displayed. Select "cancel" by pressing the ▼ Button to terminate the Sys monitor.

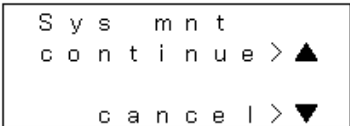

<Remote controller (RC-9018M)>

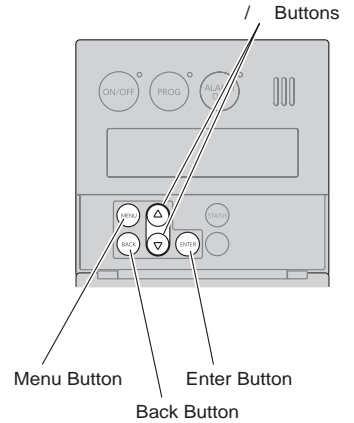



## ■ Additional settings of system controller

Following setting can be changed in addition to the system settings.  
When determining whether or not to change a particular setting, please consult with the customer first.

### - Item No. 19

When multiple units are connected to the system controller, two units fire upon startup as the factory default.

However, this setting can be changed so that only one unit fires upon startup.

### - Item No. 1A

By factory default, the remote controller alarm will sound when a failure of the system controller or any water heater in the system has occurred.

However, this setting can be changed so that the alarm sounds only when the entire system is down.

<Remote controller (RC-9018M)>

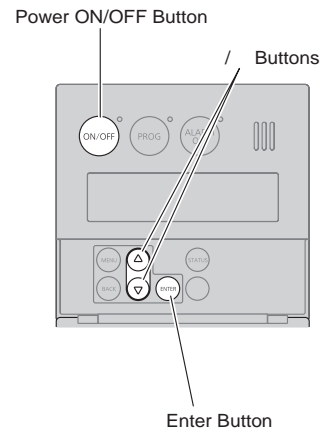

### ● Setting method (example to change Item No. 1A)

- (1) Turn the water heater off by pressing the Power ON/OFF Button on the remote controller.
- (2) Turn OFF the power supply (disconnect electrical power to all heaters), then turn ON the power supply (reconnect electrical power to all heaters) and wait 10 seconds before proceeding to step (3).
- (3) Within the first ten minutes of connecting electrical power, before turning on the Power ON/OFF Button, press the ▲/▼ Buttons on the remote controller and hold until the display blinks "99". If "99" does not blink on the remote controller, disconnect electrical power to all heaters and try again.
- (4) Use the ▲/▼ Buttons on the remote controller to scroll to the dipswitch number "1A" on the column of the item.
- (5) Press the ENTER Button, "Item number" stops blinking and "Data state (OFF or ON)" will start blink.  
Use the ▲/▼ Buttons on the remote controller to change OFF ↔ ON.
- (6) Change "1A" from OFF to ON.  
\* Do not adjust any other dipswitches!

Item	Data
▲/▼ 1A	ON

- (7) When the dipswitch has been set correctly, press the ENTER Button, "Data state (ON)" stops blinking and "Item number" will start blink. Confirm the setting by pressing and holding both the ▲/▼ Buttons on the remote controller until the controller emits a beeping noise.  
The new setting will be lost if this is not done.
- (8) Disconnect Power to all heaters in multi-unit system.  
Wait 10 seconds or more, and reconnect power.

### List of settings

Item #	Data Indication	
19	OFF (Two units fire at startup)*	ON (One unit fires at startup)
1A	OFF (Alarm for any system error)*	ON (Alarm only for system down error)

\* Factory Default Settings

# 11. Additional Remote features

For All Systems Clock Adjustment

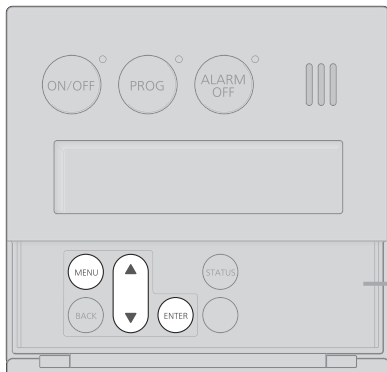

Cover shown in the open position.

Operation	Screen Display	Description
<b>1</b> Press the  button inside the cover.		* This adjustment can be made regardless of whether the  button is ON/OFF.
<b>2</b> Press the  button.		
<b>3</b> <ol style="list-style-type: none"> <li>Use the  buttons to reset the clock.</li> <li>Press the  button to complete the clock setting.</li> </ol>	<ol style="list-style-type: none"> <li> </li> <li> </li> </ol> <p style="text-align: center;">▼ The screen returns to the previous screen.</p>	* The time changes in 1-minute increments with each press of the button, and then in 10-minute increments if the button is kept pressed down.  * If the display is left untouched for approximately 20 seconds without pressing the  button, the setting will be completed. When the  button is turned ON, the home screen will be restored.



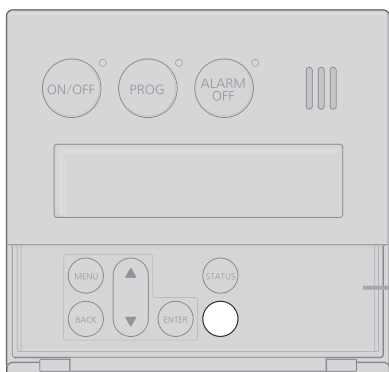











\* In the event of a power outage or after disconnecting power to the water heater, when power is restored, the clock on the display screen will show " - : - - " and the clock will need to be reset.



Cover shown in the open position.



By locking the remote controller, the settings cannot be accidentally changed if a button is pressed by mistake.

Operation	Screen Display	Description
<p><b>1</b> Press and hold  button for approximately 2 seconds to lock the remote controller.</p>	<div style="border: 1px solid black; padding: 5px; text-align: center;">                     Lock complete                      [ PROG ]  [ MENU ]                       [ Temp ]  </div>	<ul style="list-style-type: none"> <li>* The operation can be locked regardless if the  button is "ON" or "OFF".</li> <li>* The operations of , , and  buttons are locked.</li> <li>* Approximately 3 seconds after locking the remote controller, the display will return to the previous screen.</li> </ul>
<p><b>If you press these buttons</b></p> <div style="display: flex; align-items: center; gap: 10px;">    </div> <p>while the remote controller is locked, the "Locked" screen will appear.</p>	<div style="border: 1px solid black; padding: 5px; text-align: center;">                     Locked                      [ PROG ]  [ MENU ]                       [ Temp ]  </div>	<ul style="list-style-type: none"> <li>* Approximately 3 seconds after the "locked" screen appears, the display will return to the previous screen.</li> </ul>

**● To Unlock the Remote Controller**

Press and hold  button for approximately 2 seconds to unlock the remote controller.

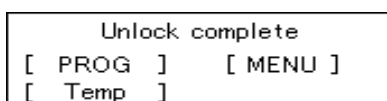

\* Approximately 3 seconds after unlocking the remote controller, the display will return to the previous screen.

## 12. Additional System Controller Features

### System Controller Terminals (Optional Connections)

#### Warning Light Terminal

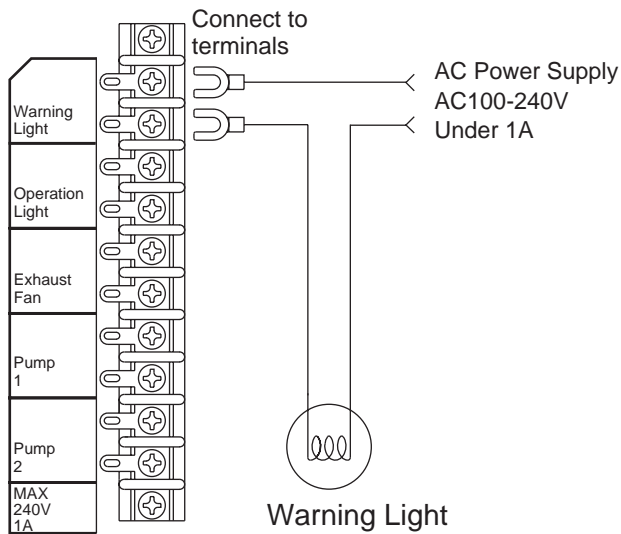

#### Operation Light Terminal

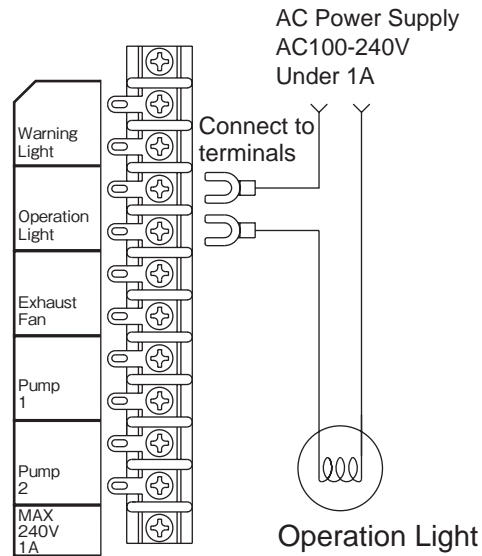

- If you make the connections as shown above, the light will turn on when a failure (error code) of any water heater in the system is generated. It will remain lit until the failure has been resolved. If the light turns on, the failure must be resolved after checking the remote controller for error code(s). The light will also turn on if the power supply to the system controller is cut off.

- If you make the connections as shown above, the light will turn on and remain on any time the system is turned on at the remote controller. If the power button is turned off at the remote controller, the light will turn off.

#### Circulation Pump Terminals 1,2

- Use these terminals to control the pumps in any circulating system. Connected this way, the system controller will control the function of the pumps. Use normally open relays (electromagnetic switches) to supply power to the pumps. Use thermal relays if necessary. Connect them when they are used for recirculation system or storage tank recirculation system.
- Use electromagnetic contactors / thermal relays suitable for the load.

1) When operating with 1 circulation pump

\* If there is only one pump, connect to "Pump 1" terminals.

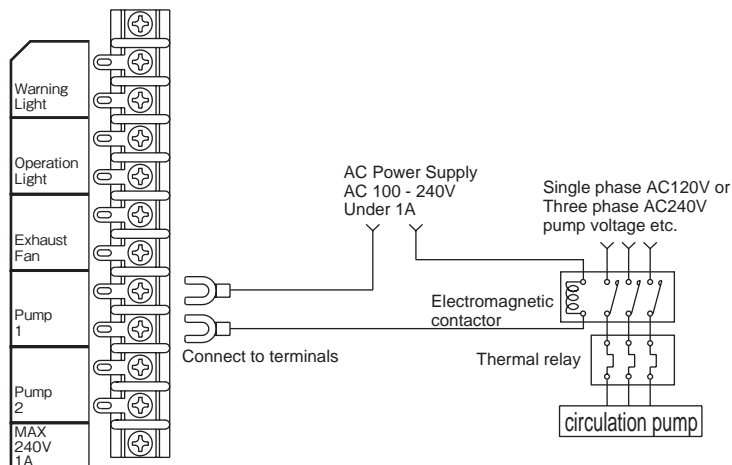

When you connect one circulation pump, set "No" for the question "Start pump rotation?" in the system settings. (refer to page 9.)

## 2) When operating with 2 circulation pumps

The system controller carries out the alternate operation of "pump 1" and "pump 2" at regular time intervals by connecting two circulation pumps.

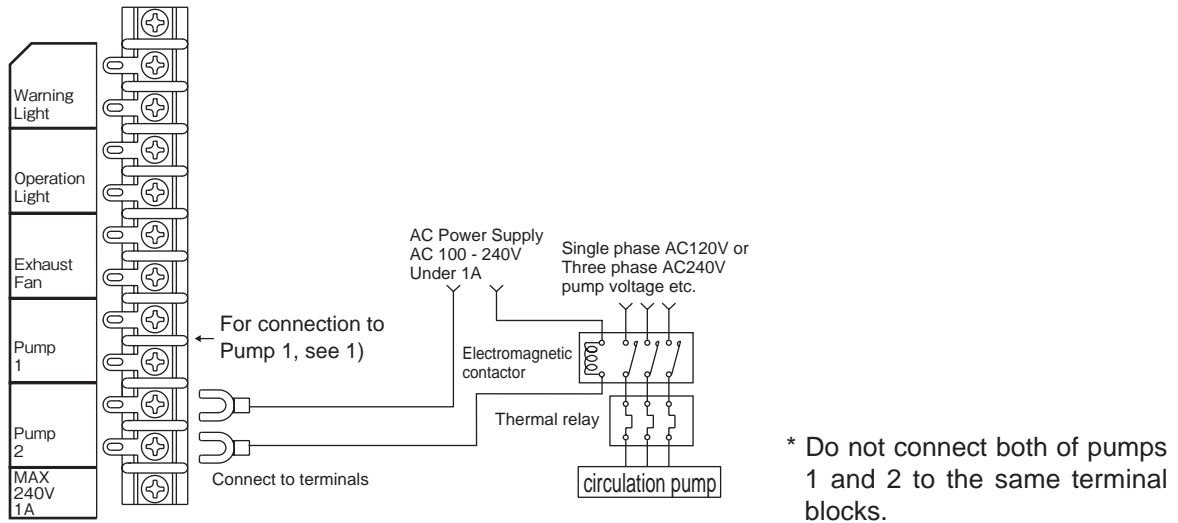

When you connect two circulation pumps, set "Yes" for the question "Start pump rotation?" in the system settings. (refer to page 9.)

### \* Piping diagram for parallel pipe installation

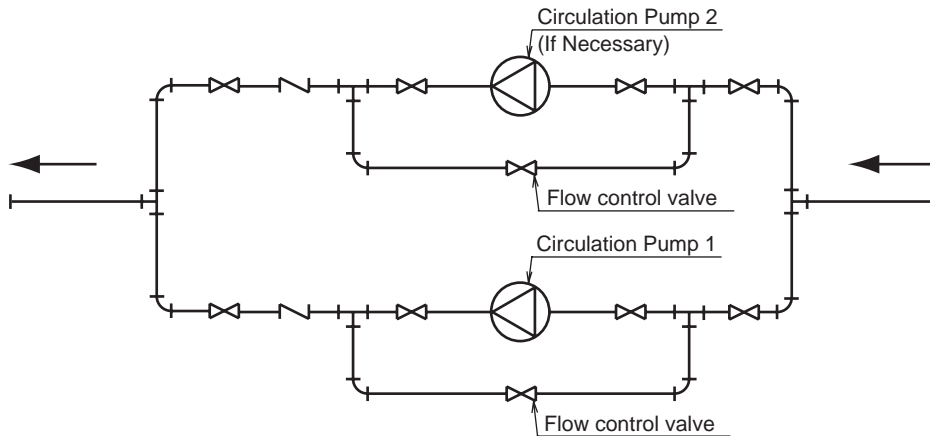

Adjust the pump flow with the flow control valves.  
If multiple pumps are used, control the flow of each pump with separate valves.

## Exhaust Fan Terminal

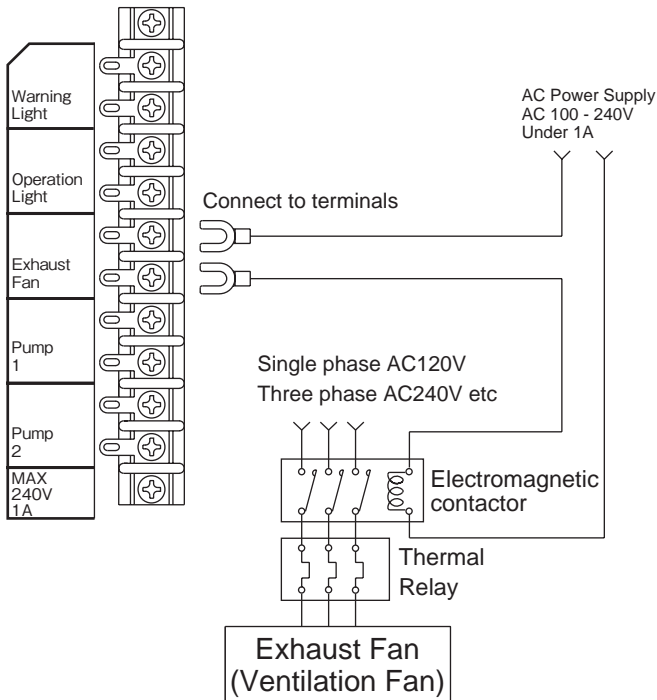

- These terminals will close when any of the units are firing or when the fan on any of the units is blowing. These terminals can be used to control an exhaust fan or damper in this way.
- Use a relay (electromagnetic contactor) to provide power to the fan or damper. Use an additional thermal relay if necessary.
- Use the electromagnetic contactor / thermal relay suitable for the load.

## ■ Connections of Pressure Switch, External Operation Switch, and Thermostat (input terminals)

\* The input terminals are collected on the rear surface of the terminal block of the system controller.  
Pull out the wires after checking the tags.

### Connecting the Pressure Switch

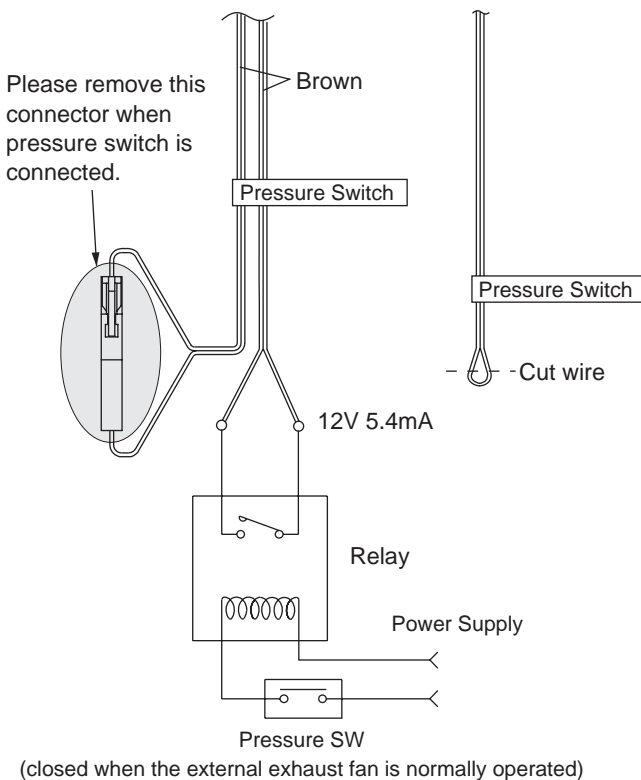

- A pressure switch or other item can be attached as a safety device when an external exhaust fan that is attached to the exhaust fan terminal above does not operate.
- If the status that a contact of the relay is opened continues, the system stops.
- Use the normally open relay with the contact for low voltage.
- This terminal is short-circuited when the product is shipped from factory. When you use this feature, cut a short-circuit electric wire and connect relay, and then disconnect a short-circuit connector.

## Connecting the External Operation Switch

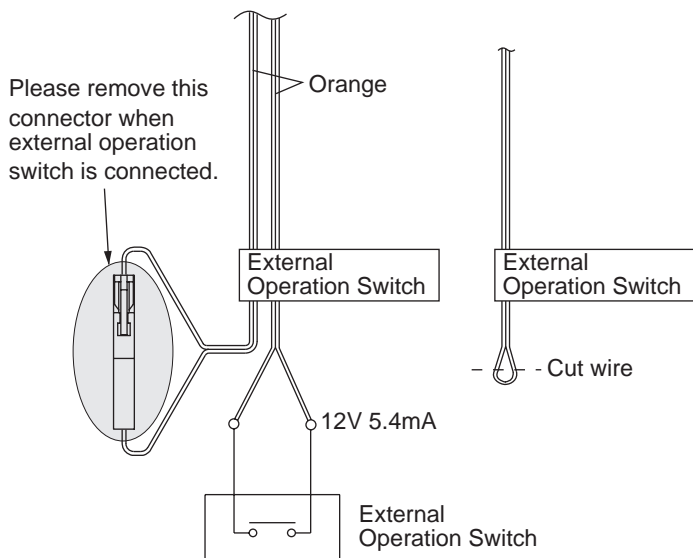

- Connect the external operation switch when you want to turn ON/OFF the water heater from external in addition to the Power ON/OFF Button of the remote controller.
- If the terminal of the external operation switch is switched from open to short, the Power ON/OFF Button of the water heater is turned "ON".
- If the terminal of the external operation switch is switched from short to open, the Power ON/OFF Button is turned "OFF".
- Use the normally open relay with the contact for low voltage.
- This terminal is short-circuited when the product is shipped from factory. When you use this feature, cut a short-circuit electric wire and connect the external operation switch, and then disconnect a short-circuit connector.

- For the external operation switch

- Whether the Power ON/OFF Button is synchronized or not to the cycle operation can be changed by switching the setting. (it can be changed only for recirculation system).

If the external switch is switched from open to short, the setting is switched as shown below.

Power ON/OFF Button is synchronized: Power ON/OFF Button is turned "ON", cycle operation is turned "ON"

Power ON/OFF Button is not synchronized: only Power ON/OFF Button is turned "ON"

## Connecting the Thermostat

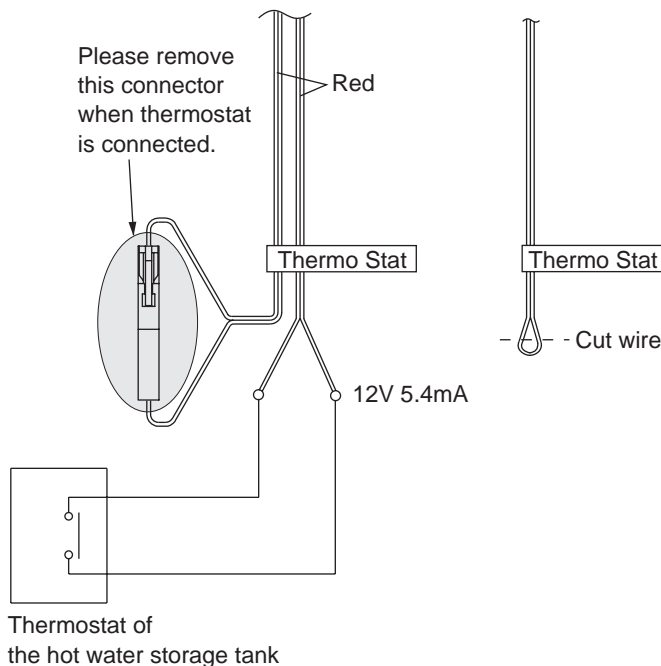

- Connect the thermostat of the hot water storage tank.
- If the temperature of the hot water storage tank exceeds the temperature set with the thermostat, the contact in the thermostat is opened and the circulation pump stops.
- A platinum resistance temperature detector cannot be connected directly.
- This terminal is short-circuited when the product is shipped from factory. When you use this feature, cut a short-circuit electric wire and connect the thermo stat, and then disconnect a short-circuit connector.

# 13. System design, Gas, and Water piping

## ■ System diagram (When six units are installed)

### ● Installation without a recirculation system (Standard System)

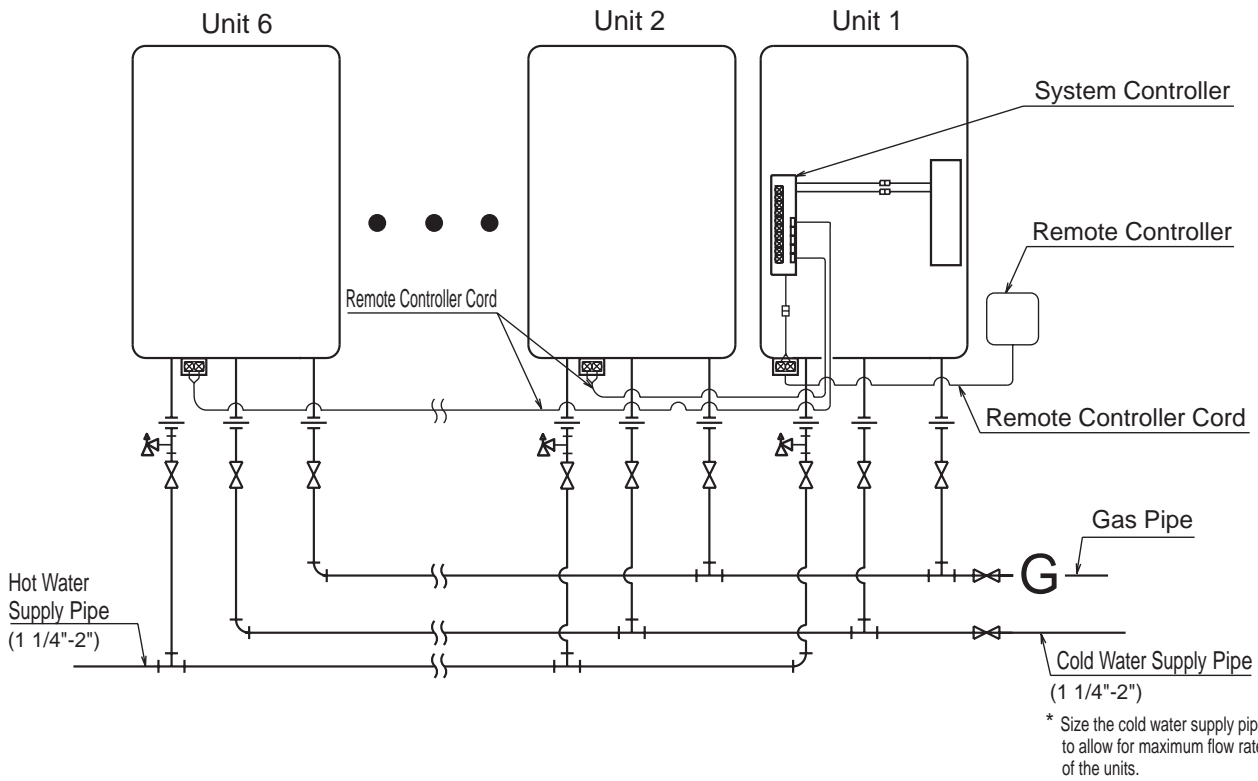

- Insulate or apply heating materials to both the cold water supply piping and the hot water supply piping to prevent freezing during cold weather and to prevent heat loss through the piping.



● Example of Recirculation with a Multi-unit System (Recirculation system)

This system will make hot water more quickly available to remote fixtures.

The pump will circulate water through the loop until the entire loop is warm, and then the system controller will turn off the pump until the loop cools down.

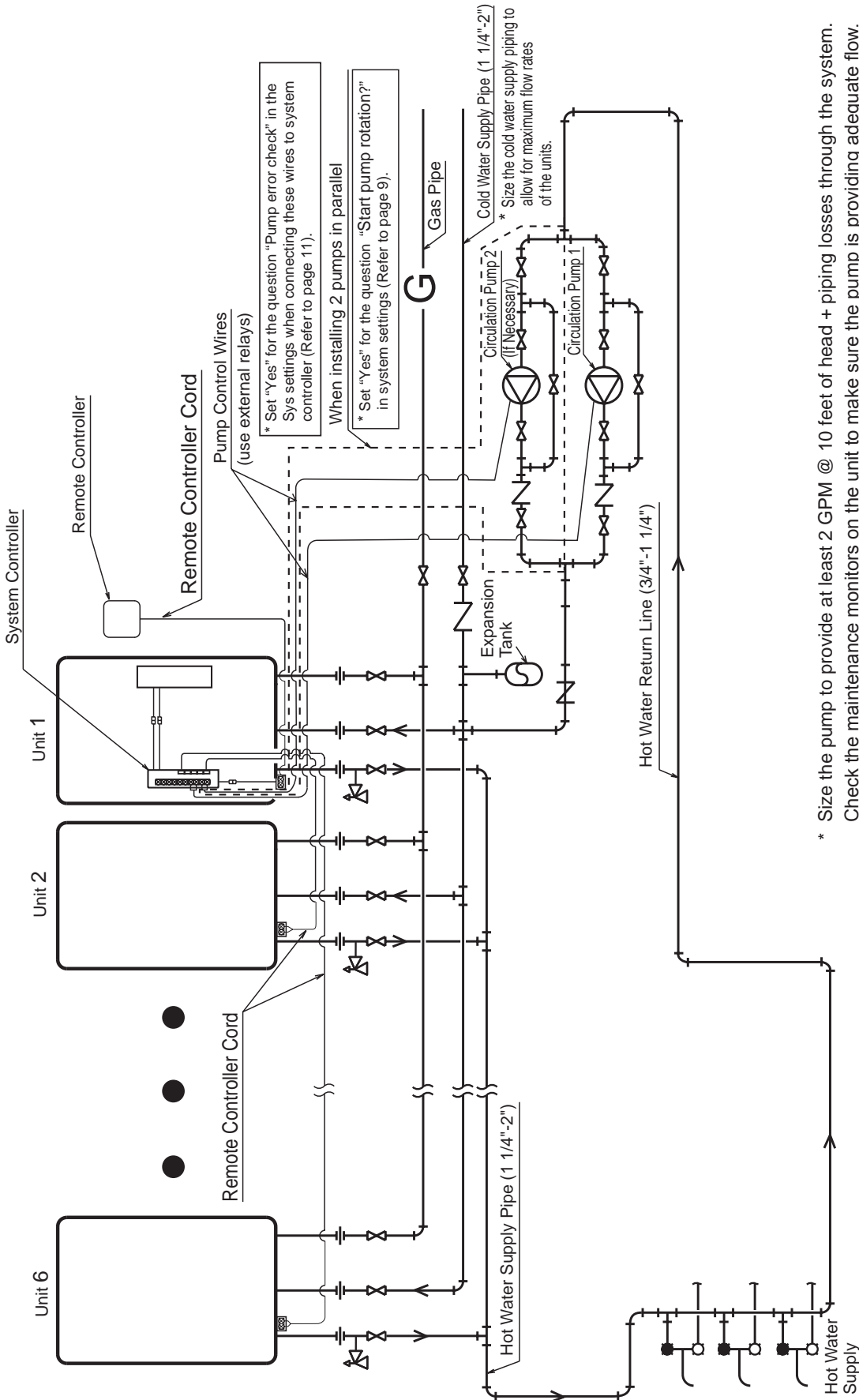

\* Size the pump to provide at least 2 GPM @ 10 feet of head + piping losses through the system. Check the maintenance monitors on the unit to make sure the pump is providing adequate flow.

• Make sure that the flow rate is not greater than 4 ft./sec. (3/4": 5 GPM, 1 1/4": 13 GPM)

If the flow is too low, the recirculation loop temperature will not be warm enough, if the flow is too high, the lifetime of the unit will be reduced.

\* If there are multiple circulation loops, try to make the flow rate .75-1.25 GPM in each loop.

\* Use copper or stainless water piping for the entire system.

● Example of Installation with a Storage Tank and Recirculation System (Tank recirculation system)

The pump will push water through the Multi-unit System to heat up the tank.  
 When the temperature of the thermostat is high, the system controller will turn off the pump until the the temperature cools down.

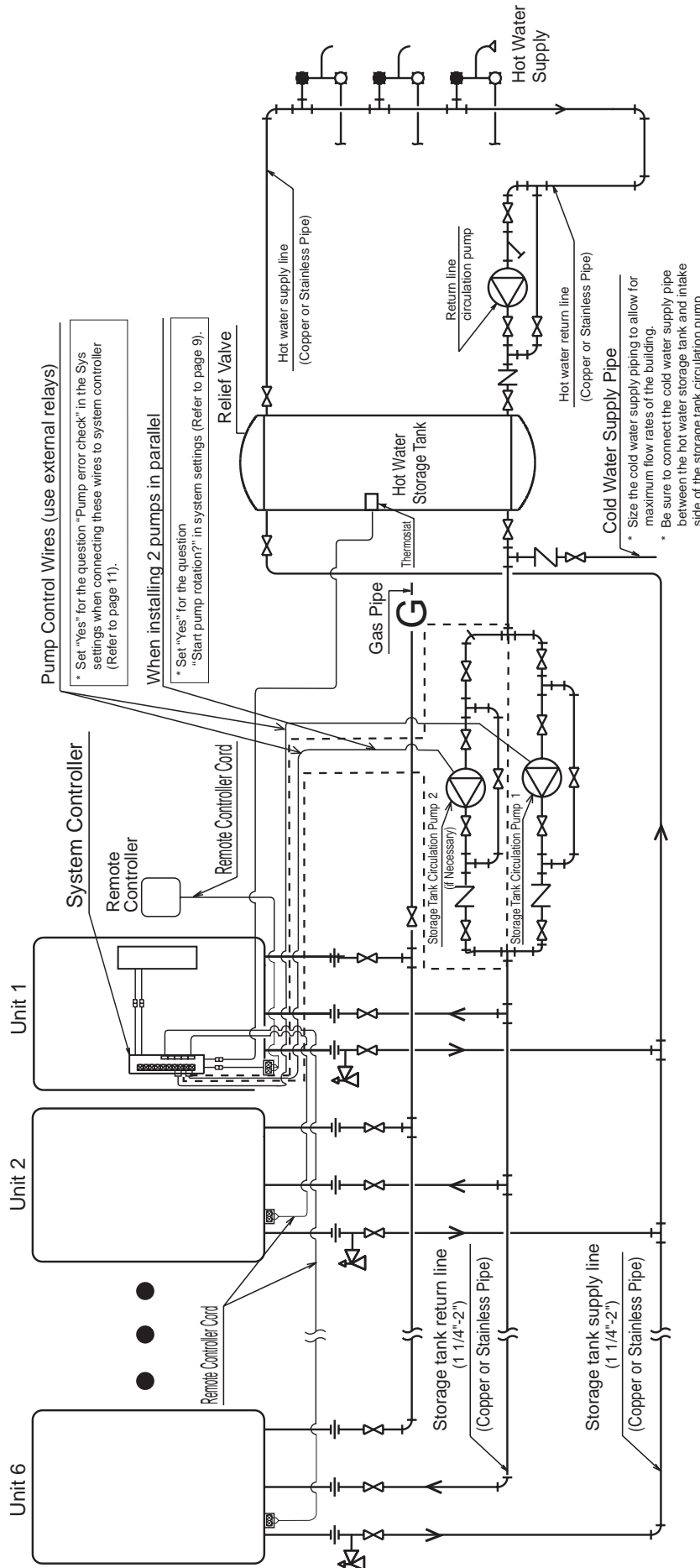

- \* Set "Yes" for the question "Pump error check" in the Sys settings when connecting these wires to system controller (Refer to page 11).
- When installing 2 pumps in parallel
- \* Set "Yes" for the question "Start pump rotation?" in system settings (Refer to page 9).
- \* Size the cold water supply piping to allow for maximum flow rates of the building.
- \* Be sure to connect the cold water supply pipe between the hot water storage tank and intake side of the storage tank circulation pump.
- \* For the set temperature of the remote controller, use the temperature (of the thermostat) + about 10°F.
- \* To achieve the highest recovery, size the storage tank circulation pump for maximum capacity. (9 GPM (each) @ 40 ft. of head (160°F setting or less) + piping losses through the system.) Verify the supply pressure to the units is at least 30 PSI.

## ■ Gas piping

\* Follow the instructions from the gas supplier.

### ■ Gas connection

- Gas flex lines are not recommended unless they are sized for the maximum input kW (Btu/h • MJ) of each unit.
- Do not use piping with a diameter smaller than the size of the gas inlet to each unit.
- After installation, check the gas line for any leaks before using.

### ■ Gas Valve

Install a gas shutoff valve for every unit installed.

### ■ Gas Meter

Select a gas meter capable of supplying the entire kW (Btu/h • MJ) demand of all gas appliances that the meter serves. Size the gas line for the entire kW (Btu/h • MJ) demand also.

## ■ Water piping

\* Ask a qualified plumber to perform the installation.

\* Observe all applicable codes.

- The plumbing should be installed by a qualified plumbing contractor according to all applicable codes and regulations.
  - Insulate or apply heating materials to the supply and hot water piping to prevent freezing during cold weather and to prevent heat loss through the piping.
  - Use a union coupling or flexible pipe for connecting the units to ease service and maintenance.
  - Refer to the system diagrams for supply and hot water pipe sizing. Do not install piping that is smaller than the inlet or outlet water connections on the units.
  - If using an expansion tank, make sure it is correctly sized for the system.
  - Use only copper or stainless steel pipe for all plumbing.
  - Keep the plumbing as simple as possible.
  - Avoid using pipes in which air can accumulate.
- \* Use only approved materials, and have the installation inspected upon completion.

# 14. Follow-up Service

## ■ Checking for Error Conditions

When a failure occurs, information relating to the error blinks on the display. The error alarm may also continuously sound.

- Error Code Display Screen

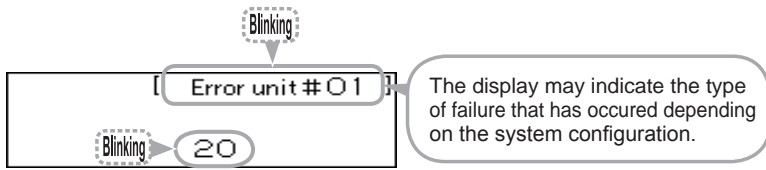





- To Stop the Error Alarm

Press the  button (the indicator will turn off).



## ■ Requesting Service

- \* Service and warranty periods are based on the type of product and the application type. Refer to the Limited Warranty provided with the water heater for complete details.
- \* Refer to the "Troubleshooting" section in the Owner's Guide supplied with the water heater. If the problem is not corrected, contact Noritz America Technical Support at 866-766-7489 or visit <http://support.noritz.com/>.

- Press the  button to check the status of the system

Operation	Screen Display	Description
<b>1</b> Press the  button inside the cover.	<pre>System [ Rrcr ] Active [ 04 ] Units   [ 06 ] Pump1 [ OFF ] Online  [ 04 ] Pump2 [ ON  ]</pre> <p>&lt;Screen display (Example)&gt;</p>	<p>* Status can be checked regardless of whether the  button is ON/OFF.</p> <p>* If the  button is pushed or it is left untouched for approximately 10 minutes, it will return to the previous screen.</p>

### • Identifying units that require service (system dependent).

Press the  button twice inside the cover.	<pre>Error unit 1  -  -  -  -  6  -  -</pre> <p>&lt;Screen display (Example)&gt;</p>	<p>* If you press the  button, the screen of step 1 is displayed.</p> <p>If you press the  button, the screen returns to the previous screen.</p>
--	--	---

If at any time during the installation and setup of this product you have questions or concerns, please contact Noritz America Engineering & Service at 866-766-7489 or visit <http://support.noritz.com/>.